

# GRANULE PACKING FILLER AF-25K



**5-25kg**  
Weighing range

**±10g**  
Accuracy

**900+ Pcs/h**  
Speed



Stable Performance



Easy Installation



Servo Motor Control



Weighing Accurate

## Features:

- **Granular material:** design for plastic particle, granular fertilizer, feeds and other granular material.
- **Easy dismounting:** module design of measuring hopper for easy cleaning.
- **Parameter setting:** self-adjust function with target value set only
- **Stable performance:** servo motor controls feeding process
- **Weighing accurate:** weighing range is 5-25kg. Speed can reach 900 pcs/h and accuracy is ±10g.

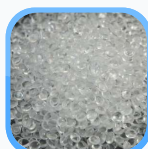
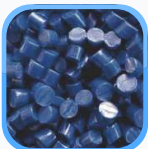

## Optional:



Bag Clamp

- SS304 stainless steel.



10-inch touch screen

- User-friendly interface design, vivid display, easy to operate.

## Specification

Model	PaxGo AF-25K
Weighing range	5~25Kg
Division	1g
Accuracy *	±10 g
Speed *	900pcs/h
Volume	55L
Feeding method	Feeding control by servo, pneumatic discharging
Material	SS304, carbon steel
I/O	8 output(5V), 8 input(24V)
Communication	RS485, Modbus TCP/IP
Pneumatic	0.4~0.6MPa
Power	Single Phase AC-220V ±10%, 50/60HZ
Working environment	0~40°C, 90%R.H condensation is not allowed

\* Normally, the diameter of the testing material 1-5mm

## Structure & Dimension

Unit: mm

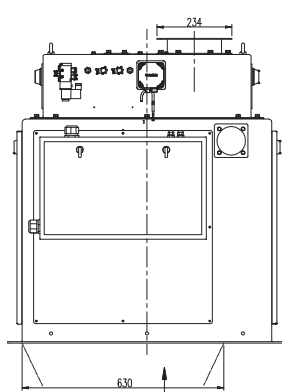

A (Bottom frame dimension)

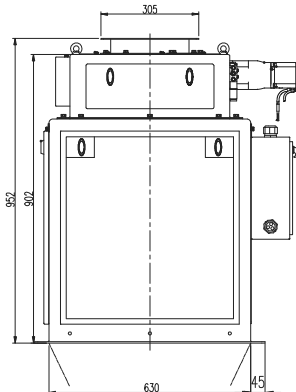

A (Bottom frame dimension)

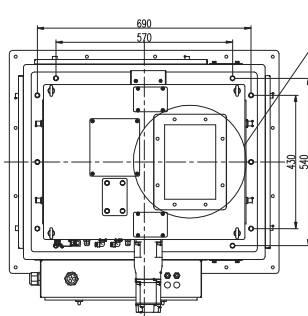
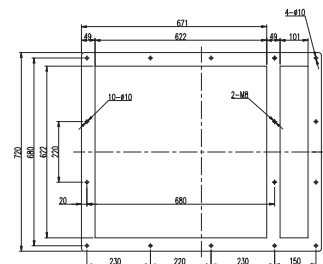

B (Feeding port dimension)

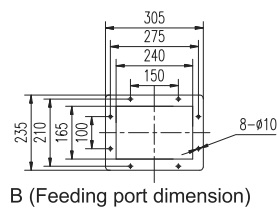

B (Feeding port dimension)

## **BARRANQUILLA**

Cll. 45 No. 39 - 07 PBX.: (605) 370 3366

Cra. 40 No. 37 - 55 Tel.: (605) 379 23 13

## **MEDELLIN**

Carrera 43G No. 26 - 75 Tel: (604) 401 77 07

## **CALI**

Carrera 10 No. 9 - 08 Tel: (602) 895 96 23

[www.macoser.co](http://www.macoser.co)



info@macoser.com.co



@macoser.co



**MACOSER®**