

DUPLEX PACKING FILLER AF-25K II

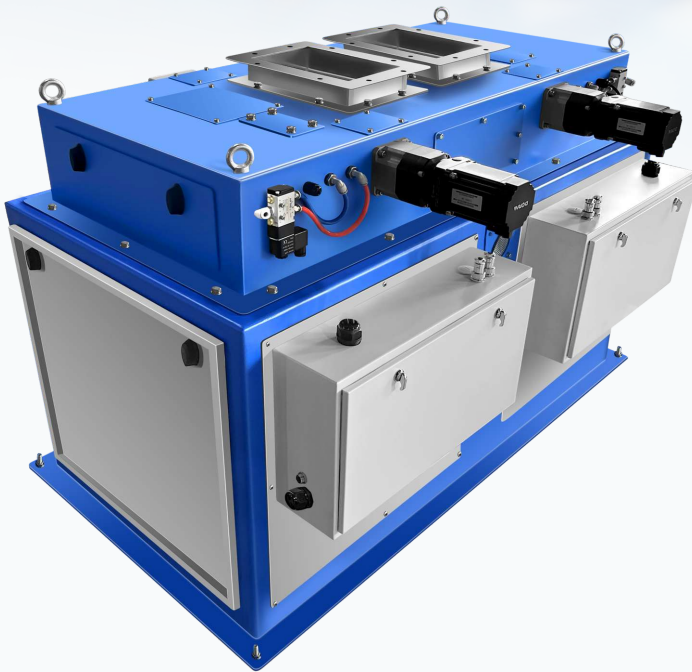

5-25kg
Weighing range

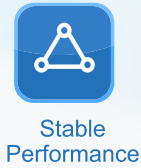

± 10g
Accuracy

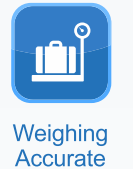
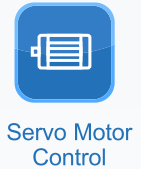

1600 + Pcs/h
Speed

Features:

- **Granular material:** design for plastic particle, granular fertilizer, feeds and other granular material.
- **Easy dismounting:** module design of measuring hopper for easy cleaning.
- **Parameter setting:** self-adjust function with target value set only
- **Stable performance:** servo motor controls feeding process
- **Weighing accurate:** weighing range is 5-25kg. Speed can reach 1600 pcs/h and accuracy is ±10g.

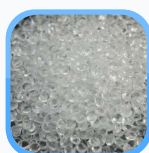
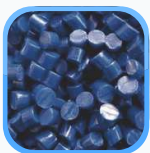

Optional:



- SS304 stainless steel.



- User-friendly interface design, vivid display, easy to operate.

Specification

Model	PaxGo AF-25KII
Weighing range	5~25Kg
Division	1g
Accuracy *	±10 g
Speed *	≥1600 pcs/h
Volume	55L×2
Feeding method	Feeding control by servo, pneumatic discharging
Material	SS304, carbon steel
I/O	8 output(5V), 8 input(24V)
Communication	RS485, Modbus TCP/IP
Pneumatic	0.4~0.6MPa
Power	Single Phase AC-220V ±10%, 50/60HZ
Working environment	0~40°C, 90%R.H condensation is not allowed

* Normally, the diameter of the testing material 1-5mm

Structure & Dimension

Unit: mm

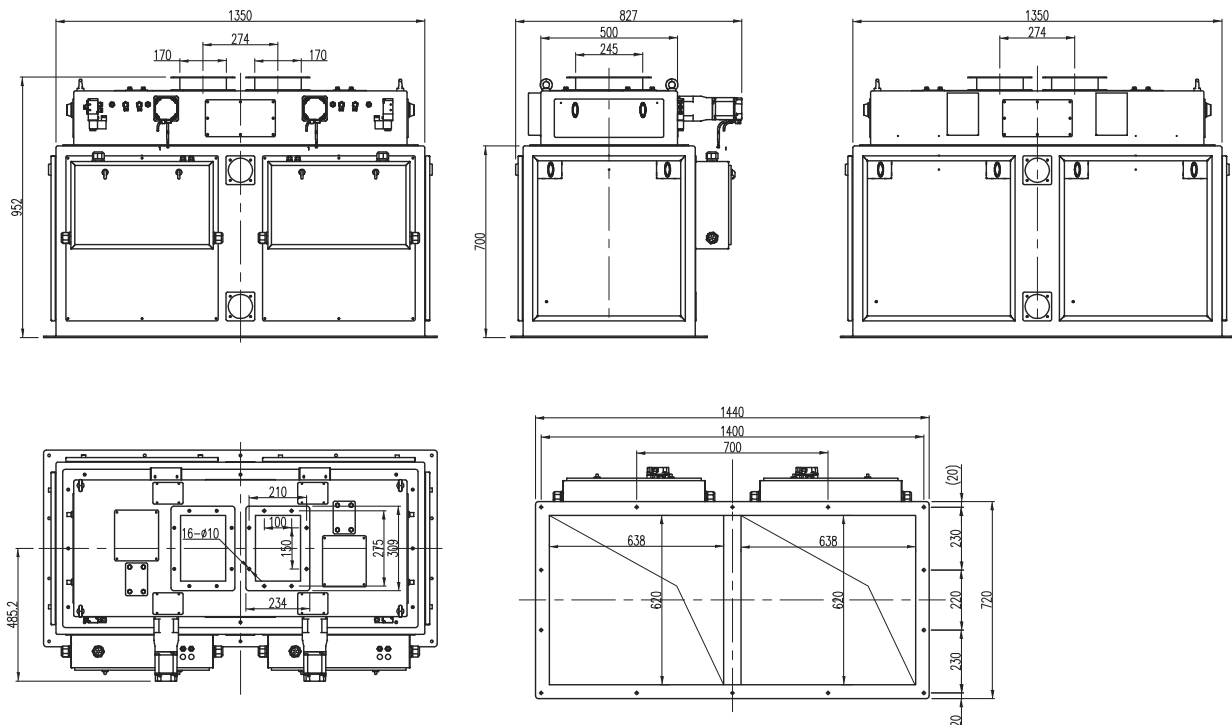

BARRANQUILLA

Cll. 45 No. 39 - 07 PBX.: (605) 370 3366

Cra. 40 No. 37 - 55 Tel.: (605) 379 23 13

MEDELLIN

Carrera 43G No. 26 - 75 Tel: (604) 401 77 07

CALI

Carrera 10 No. 9 - 08 Tel: (602) 895 96 23

www.macoser.co



info@macoser.com.co



@macoser.co



MACOSER®